

Varenummer: 03554035

Beskrivelse: Fluro hydraulik ledhoved FMA 35D

Mål

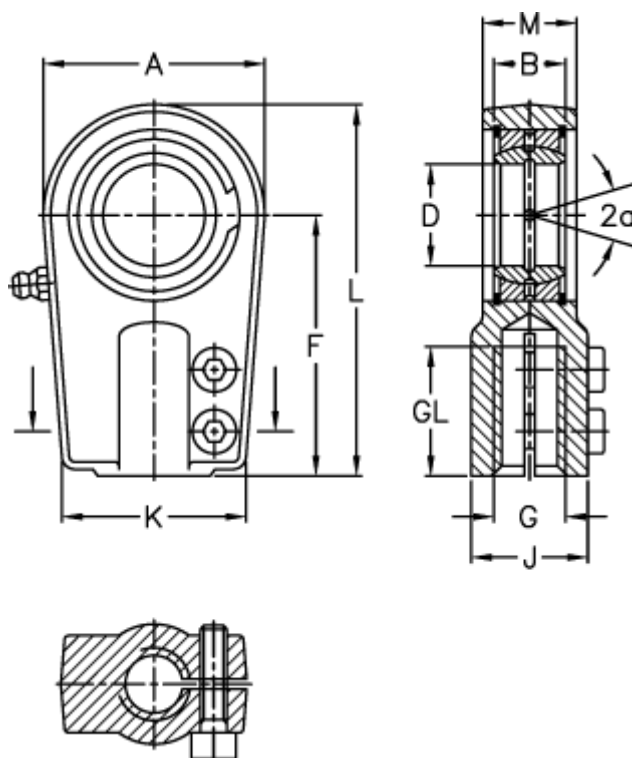

A	= 78	J	= 44
a (grader)	= 7	K	= 66
B	= 25	L	= 132
D	= 35	M	= 30
Dynamisk belastning C (kN)	= 112	Moment (Nm)	= 40
F	= 90	Statisk belastning C0 (kN)	= 185
g	= M30x2	Vægt	= 1300
GL	= 45		